

Transceiver-power Control for 802.15.4a UWB-IR Ranging in the Presence of Multipath Propagation

Tingcong Ye
Tyndall National Institute
University College Ireland, UCC,
Cork, Ireland
Email: tingcong.ye@tyndall.ie

Brendan O'Flynn
Tyndall National Institute
Cork, Ireland
Email: brendan.oflynn@tyndall.ie

Michael Walsh
Tyndall National Institute
Cork, Ireland
Email: michael.walsh@tyndall.ie

Cian O'Mathuna, *Fellow, IEEE*
Tyndall National Institute
Cork, Ireland
Email: cian.omathuna@tyndall.ie

Abstract—Sensor networks can benefit from location-awareness, since it allows information gathered by sensors to be tied to their physical locations. The emerging IEEE 802.15.4a Ultra Wideband Impulse Radio (UWB-IR) transmission is a promising technology for ranging and location-aware sensor networks, due to its fine time resolution and power efficiency. However, the presence of multipath propagation presents a significant challenge in terms of ranging, as they can result in biased distance estimates. In this paper, we present multipath effects mitigation methods using bilateral transceiver-power control algorithms, which are capable of: (i) optimizing the signal to noise ratio (SNR) of leading path signal and maintaining the connectivity; and (ii) cooperating with a practical symmetric double-sided two-way ranging protocol. Relevant aspects of power control are discussed using an automatic control framework. We evaluate the resulting performance and compare with existing non-power control techniques. Experimental results show that the proposed multipath effects mitigation approach is more robust against the non-power control based ranging errors.

Keywords—802.15.4a UWB-IR, Transceiver-power Control, Ranging, Multipath Propagation.

I. INTRODUCTION

Location-awareness becomes an essential aspect of wireless sensor networks (WSNs) and will enable a wide variety of applications, in both the commercial and the military sectors. Ultra Wideband Impulse Radio (UWB-IR) transmission provides robust signaling, as well as high resolution ranging capabilities [1]. Therefore, UWB represents a promising technology for ranging and localization applications through time-of-arrival (TOA) technique [2], [3]. IEEE has recognized the need to standardize UWB technology for use in personal area networks (PANs) and has established the IEEE 802.15.4a standard specifying a new UWB physical layer for WSNs [4]. In practical scenarios, however, a number of challenges remain before UWB ranging and communication can be deployed. These mainly include uncommon time reference, clock drift, low sampling rate, multipath propagation and non-line-of-sight (NLOS) propagation. The use of practical Symmetric Double-Sided Two-Way (SDS-TW) ranging protocol [4] and Energy Detector based TOA estimation methods [5]-[7] can

significantly solve the uncommon time reference, clock drift and low sampling rate issues. In real-world environment, the multipath propagation issue is especially critical for 802.15.4a ranging system, since uncertain multipath effects (like reflection, scattering and diffraction) introduce noise sources in the TOA estimation, thus seriously affecting the Signal-to-Noise (SNR) of the leading path signal and ranging performance. Indoor environments have a high occurrence of multipath propagation situations. It is therefore critical to understand the impact of multipath propagation on 802.15.4a ranging systems and to develop techniques that mitigate their effects.

Super-resolution TOA technique is proposed to estimate the channel multipaths TOA and amplitude using MUSIC [8]. A pattern to identify closely-spaced direct path and ground reflection is given in [9]. The main drawback of existing multipath mitigation techniques is difficulty in determining the direct path and the large number of multipath components especially when paths overlapping. The Cramer-Rao lower bound of TOA shows that SNR is, a more accurate indication of the link status and ranging accuracy [10]. This paper considers a channel quality improvement approach. In particular, we propose the use of power control to optimize the SNR and thus performing multipath mitigation. Power control algorithms for wireless communication systems have been investigated and designed to satisfy the QoS requirements [11]. The IEEE 802.15.4 (Zigbee) based mobile tracking system has used the power control methods to solve the location error [12]. In this work, we firstly performed an extensive indoor measurement campaign with FCC-compliant 802.15.4a UWB radios to quantify the effect of multipath propagation. From these channel impulse responses, we extract features that are representative of the multipath propagation conditions. We then develop multipath effect mitigation algorithms based on bilateral transceiver-power control protocol. Performance comparison is made with the non-power control scheme.

The rest of the paper is organized as follows. Section II introduces a practical ranging method and SNR estimation. Section III analyzes the features of multipath propagation. Section IV describes bilateral power control algorithms. Numerical

performance results are provided in Section V, and we draw our conclusions in Section VI.

II. IEEE 802.15.4A RANGING AND SNR CALCULATION

To solve the uncommon time reference and clock drift issues, 802.15.4a ranging system [14] employs a Symmetric Double-Sided Two-Way (SDS-TW) ranging protocol [4] and its architecture is illustrated in Fig.1 (a). It requires both transceivers to record time-of-transmitting (TOT) values and TOA values to measure round-trip times (RTT) and the time-of-flight (TOF). In practical implementation, the TOF calculation can be expressed as:

$$TOF = \frac{RTT_L - D_F + RTT_F - D_L}{4} \quad (1)$$

Where, $RTT_L = TOA2 - TOT1$ is the round-trip time of leader, $D_F = TOT2 - TOA1$ is the response delay of follower, $RTT_F = TOA3 - TOT2$ is the round-trip time of follower, and $D_L = TOT3 - TOA2$ is the response delay of leader. And the distance is:

$$d = \dot{c} \times TOF \quad (2)$$

Where, d is the antenna-to-antenna distance and \dot{c} is the speed of electromagnetic waves.

A. Performance Limits of TOA-based Ranging

Ideally, TOA estimate is given by the time instant corresponding to the maximum absolute peak at the output of the marched filter over the observation interval. The performance of the estimator achieves the Cramer-Rao Lower Bound (CRLB) for signal SNR in AWGN channel as described in [10]. The mean square error of any unbiased estimate $\hat{\tau}$ of the true TOA τ can be lower bounded by:

$$V(\xi) \geq \frac{1}{2\sqrt{2\pi}B\sqrt{SNR}} \quad (3)$$

Where, the $V(\xi)$ is the variance of TOA error, $\xi = \hat{\tau} - \tau$ is the TOA error. B is the effective signal bandwidth. It shows that SNR is a more accurate indication of the ranging performance.

B. SNR Calculation of 802.15.4a Impulse Signal

The SNR, computed by the receiver, is equal to the difference between the power of received signal and the noise power. The received signal power depends on the transmission power, the distance between transmitter and receiver, the environment (walls, obstacles will reflect and distort the signal creating a multipath effect) and interference from other sources. There are many SNR models have been proposed, one is the most correct SNR model [13] is:

$$SNR = \left(\sum_{i=1}^N (SNR_i)^{-1} \right)^{-1} \quad (4)$$

Where, $SNR_i = E_r/E_i$, E_r is the desired received signal power, E_i is related to i^{th} noise sources including multipath components, multiple-user interference and thermal noise. It is worth noting that due to multipath effects, a Gaussian random path loss variable $N(0, \sigma)$ exists in the path loss model with a zero mean and σ standard deviation.

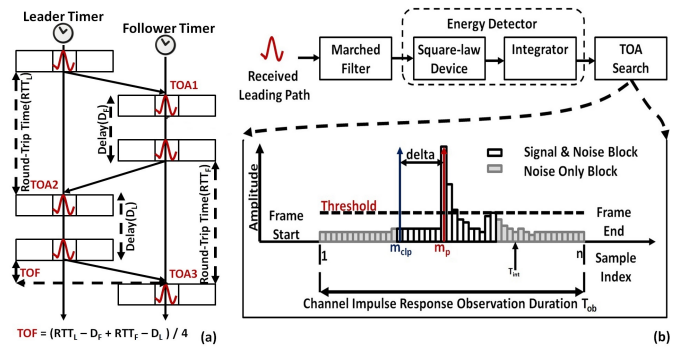

Fig. 1: (a) SDS-TW protocol and (b) Energy Detector based TOA estimator.

The SNR of the received leading path signal is measured in the leading path channel impulse response in this work, see Fig.1 (b). The received leading path signal is first passed through a marched filter (MF). The observed signal forms the input to the Energy Detector (ED), whose output is sampled at every T_{int} seconds, T_{int} is the tick time units. T_{ob} is the Channel Impulse Response (CIR) observation duration. $n = T_{ob}/T_{int}$. The system searches the index with peak power m_p in the CIR. The received signal power is with two-sided power spectral density in the CIR and the m_p is the central axis. According to signal sampling duration T_s , the effective signal duration in the CIR should be $2\kappa T_{int}, \kappa = T_s/T_{int}$. The total signal power is then measured by $P = \sum_{i=m_p-2\kappa}^{m_p+2\kappa} P_i$. P_i is the power of i^{th} index. The average power of all indices of the effective signal is $P_a = P/4\kappa$. The deviation is then calculated as the noise part $P_n = (\sum_{i=m_p-2\kappa}^{m_p+2\kappa} (p_i - P_a)) / 4\kappa$. Hence, the effective signal part is calculated as $P_r = (\sum_{i=m_{clp}}^{m_{clp}+2\kappa} p_i) - 2\kappa P_n$. m_{clp} is the time stamp window index, as indicated by first byte of channel response read. The SNR of received leading path is:

$$SNR = 10 \log(P_r/P_n) \quad (5)$$

III. MULTIPATH EFFECTS OBSERVATION

The aim of this experimental effort is to build a database containing a variety of propagation conditions (without multipath and with multipath). The measurements were made using two the world's first IEEE 802.15.4a standard compliant UWB-IR transceivers that were developed by Decawave Company [14]. Both transceivers (called leader and follower respectively) set up a typical ranging system to measure the antenna-to-antenna distance and record the ranging measurements. The 802.15.4a UWB-IR ranging parameters are listed in Table I. To compare the features of non-multipath and multipath propagation, ranging measurements were implemented in an anechoic chamber (AC) (without multipath propagation) and in an indoor office (OFC) (with multipath propagation), using a distance of 0.7m in LOS condition, see Fig.2 (a) and (b). Various transmission ranges are selected to capture a variety of operating conditions from 2.5m to 30m, see Fig.2 (c). The ranging error is shown using the empirical cumulative distribution function (CDF).

The Channel Impulse Response observation duration is 992

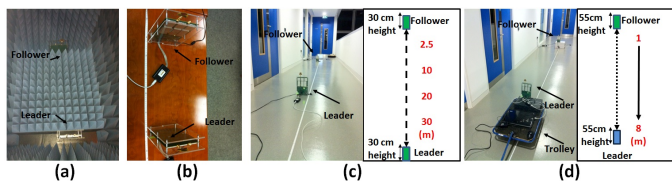

Fig. 2: Ranging Experimental Setup: (a) Anechoic Chamber; (b) Office (c) Hallway; (d) Hallway (mobile).

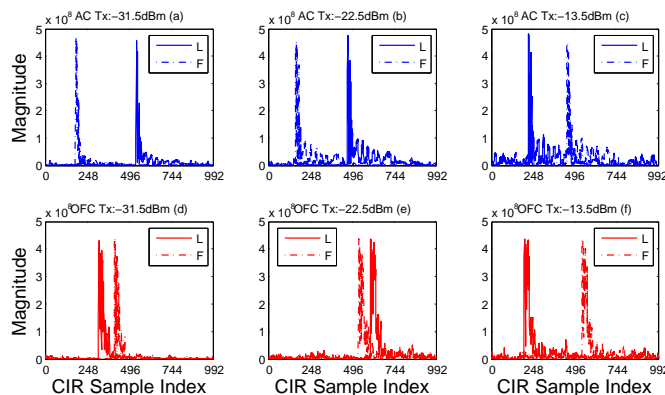

Fig. 3: Channel Impulse Response captured at anechoic chamber (a), (b), (c) and indoor office (d), (e), (f).

indices. The LSB of a time value represents 1/128 of a chip time at the mandatory chipping rate of 499.2 MHz. Indices of signal are samples 998.4 MHz at 500KHz bandwidth, which is 64 times than the tick time units.

A. The impact of Multipath Effects

Fig.3 shows some channel impulse responses (CIRs) captured using different signal outputs (-31.5dBm, -22.5dBm and -13.5dBm) in anechoic chamber (AC) and an indoor office (OFC). Without multipath effects in AC, noise becomes more evident at higher transmission powers. Few adjacent peaks with comparable amplitude to the largest peak are exhibited in the CIRs and leading path detection more straightforward. With mulitpath effects in real office (OFC) environment, more

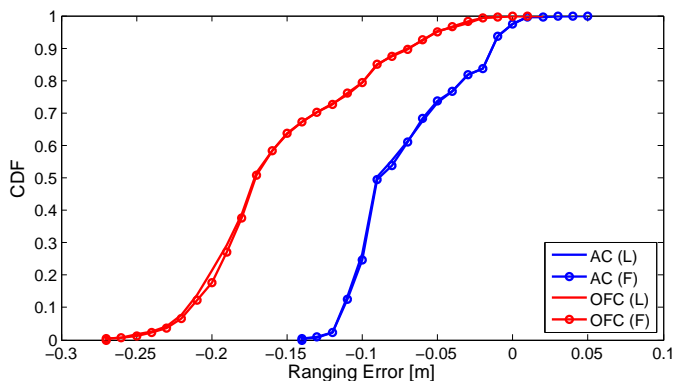

Fig. 4: CDF of the ranging error in AC and OFC.

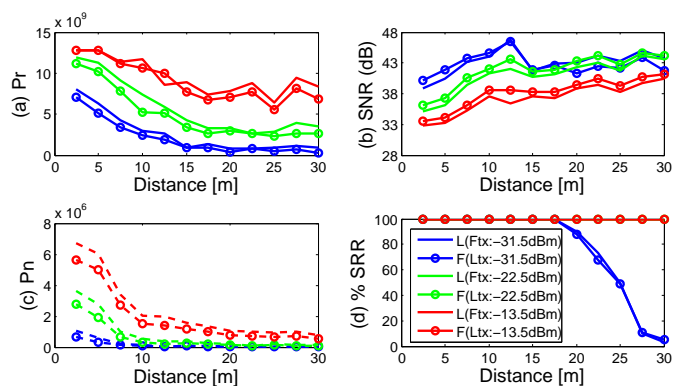

Fig. 5: Parameters measurements in different locations (a) Pr; (b) SNR; (c) Pn and (d) PRR.

TABLE I: IEEE 802.15.4a UWB Signal Parameters

IEEE 802.15.4a Channel index	2
Preamble Length	1024
Pulse Repetition Frequency	16MHz
Data Rate	850Kbits/s
Signal Bandwidth	500 MHz
Center Frequency	4 GHz
Maximum Transmit-power	-13.5dBm

adjacent peaks with comparable amplitude to the largest peak are exhibited in the channel impulse responses (CIR). The adjacent peaks increase the possibility that a reflection is selected as the leading path resulting in the introduction of ranging inaccuracy. Fig.4 shows the CDF of the ranging error. In the anechoic chamber, the ranging error below 15cm/ 10cm occurs 100% and 85% of the 7500 measurements, respectively. In the indoor office, the ranging error below 15cm/10cm occurs 20% and 5% of the 7500 measurements, respectively. Hence, we can say this practical ranging method is reliable and accurate; and the multipath propagation adversely affect the ranging performance.

B. 802.15.4a Multipath Propagation Channel

In indoor environments, due to various obstructions, the multipath effect is uncertain and random. Fig.5 shows the multipath channel features ranging from 2.5m to 30m, using different signal outputs (-31.5dBm, -22.5dBm and -13.5dBm). At a fixed distance, the higher the transmit-power, the lower the SNR, see Fig.5 (b). With the distance increasing, Received signal power (Pr) decreases almost linearly, see Fig.5 (a). However, the SNR increases with distance increasing before 10m, see Fig.5 (b). After 10m, the SNR obtained using minimum transmit-power (-31.5dBm) decreases. However, the SNR increases when using higher transmit-power (-13.5dBm). The noise power (Pn) decreases and reaches to the noise floor, see Fig.5 (c). It means that the multipath effects become less impact on the UWB signal transmission with distance increasing. The greater the transmission range, the poorer the connectivity and the lower the signal receive rate (SRR), see Fig.5 (d). Hence, there is a tradeoff between SNR and connectivity.

IV. BILATERAL TRANSMITTER POWER CONTROL ALGORITHMS

A. Power Control Aspects

Being subjective, some relevant aspects of the power control in 802.15.4a UWB ranging system should be considered.

- Ranging algorithm. This is the basic framework for UWB ranging system. Power control loop should be integrated into this framework.

- Power constraints. The transmission powers are considered due to the device limitations and the FCC limits.

- Time delays. Measuring and control signaling take time, resulting in time delays are typically fixed due to standardized signaling protocols.

- Tradeoff management. The one is the most correct BER expression [1] is:

$$BER = \frac{1}{2} \operatorname{erfc} \left(\sqrt{\frac{1}{2} SNR} \right) \quad (6)$$

Where, the erfc is the error function. The BER is used to manage the tradeoff between receive-power and SNR. A set-point SNR value can be selected and related directly to BER.

B. Power Control Methods

According to the ranging algorithm, see Fig.1(a), a TOF is calculated through the bilateral communication links between the leader and the follower. Hence, both UWB transceivers need to implement the power control loop integrated into the ranging algorithm. Consider the arrangement of power control scheme at one UWB transceiver in Fig.6, the transmit-power level is increased/decreased depending whether the SNR decoded ($\gamma_j(t)$) from the j^{th} remote signal $r_j(t)$ is above or below the target SNR (γ^T), and implemented as:

$$e_j(t) = \gamma_j(t) - \gamma^T \quad (7)$$

$$p_j(t+1) = p_j(t) + \Delta e_j(t) \quad (8)$$

$$p_j(t+1) = \min\{P_{max}, p_j(t) + \Delta e_j(t)\} \\ \parallel \max\{P_{min}, p_j(t) + \Delta e_j(t)\} \quad (9)$$

From equation (7) to (9), the $e_j(t)$ is the power update command, Δ is the minimum interval of the device power settings. P_{max} is maximum transmit-power of the FCC limits and P_{min} is the minimum power of the device limits. The P_{max} and P_{min} are controlled to ensure the inherent hardware saturation limitations are not surpassed. $p_j(t+1)$ is an integrating controller with $C_j\{\Delta e_j(t)\} = \Delta e_j(t)$ in one-slot cycle. This can be denoted as quick power control (QPC). At the same time, the SNR of the leading pulse measured at local mote $\gamma_i(t)$ is sent back to the remote UWB mote for remote power control implementation.

Another power control algorithm is that makes it possible to emulate slower update rates, or to turn off power control by transmitting a series of $e_j(t)$. It can be denoted as slow power control (SPC). In a n -slot cycle ($k = 1 \dots n$), the power update command $e_j(t)$ in equation (10) is computed according to:

$$e_j(t) = \frac{\sum_{k=1}^n e_k(t)}{n} \quad (10)$$

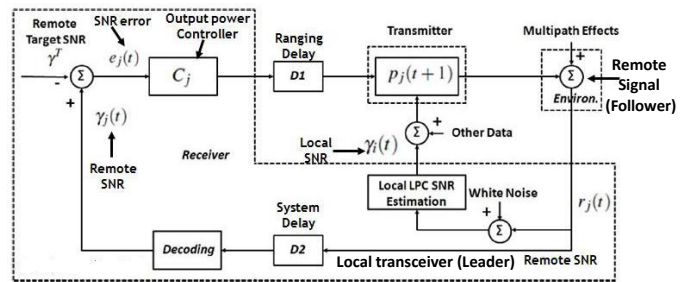

Fig. 6: Block diagram of bilateral transmitter output power control loop at local transceiver.

The decision feedback where the sign of error $e_j(t)$ is fed back resulting in equation (11):

$$s_j(t) = \operatorname{sign}(\gamma_j(t) - \gamma^T) \quad (11)$$

An adaptive fixed step size power law (FPC) is considered. The power $p_j(t)$ is increased or decreased by β dBm depending on the sign of error $s_j(t)$ as equation (12):

$$p_j(t+1) = p_j(t) + \begin{cases} -\beta, & s_j(t) < 0 \\ +\beta, & s_j(t) > 0 \end{cases} \quad (12)$$

In the ranging architecture, see Fig.1 (a), the delay, is set for mitigating the clock drift issue (about 300ms). Hence, cooperating with this ranging algorithm, there is enough time for measuring and control signaling delay ($D1$) in the power control loop. The other delay ($D2$) is the system delay which is also considered into the ranging algorithm.

V. PRACTICAL IMPLEMENTATION

The above power control methods and a pre-existing non-power control (NPC) method are critically assessed using a multipath propagation issue scenario. Stationary (from 2.5m to 30m) and mobile (from 1m to 8m with a trolley) ranging experiments are set up inside a real building, see Fig.2 (c) and (d). A target SNR value of 43dB is selected for both UWB transceivers, guaranteeing a BER of $< 3e^{-11}$, verified using equation (6). The Δ is set to be 1.5dBm and the $e_j(t)$ is round to integer. The maximum transmit-power (-13.5dBm) is selected at the beginning for strongest links. A frame is a record of the receive-time of the leading pulse according to the ranging algorithm. Basically, a ranging frame-time is about 0.6s which is equal to 2 delays (300ms) plus 2 TOFs.

A. Stationary power control test

For the purposes of clarity, the response of power control methods at a distance of 17.5m are presented graphically in Fig.7 to Fig.8. The NPC uses maximum transmit-power (-13.5dBm), see Fig.7 (d), and the response shows that system can not reach to the target SNR (43dB), see Fig.8 (d). The QPC method, using equations (7)-(9), updates the signal outputs per frame, see Fig.7 (a), and the instant SNR measured reaches the target SNR (43dB) at the first frame, see Fig.8 (a). The SPC method updates signal output every 10 frames, see Fig.7 (b), and maintains the target SNR after about 15 frames. The FPC method updates with a fixed step size, reaching to the target SNR is slower than the QPC but faster than the SPC, see Fig.7 (c) and Fig.8 (C).

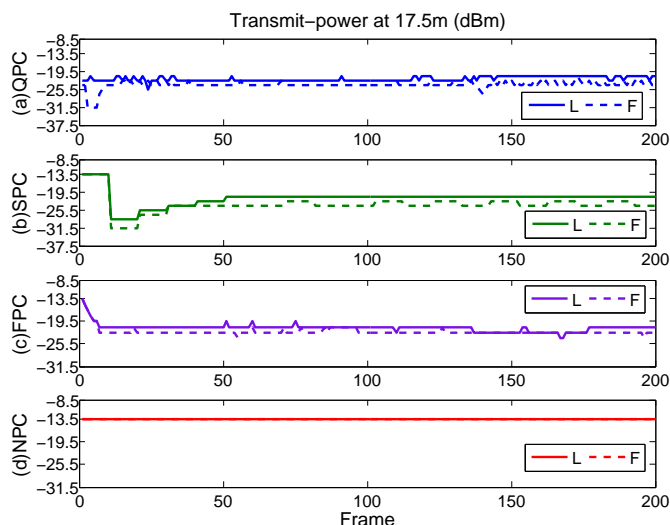

Fig. 7: Transmit-power updating at 17.5m.

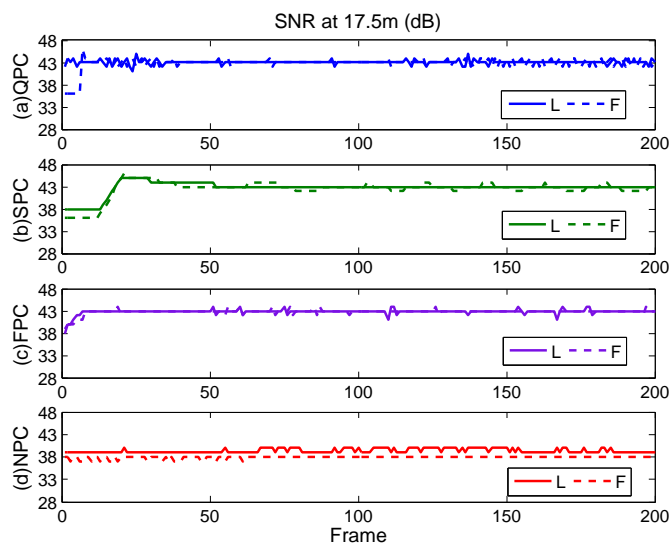

Fig. 8: SNR updating at 17.5m.

Fig.9 shows the CDF of the ranging error measured using different power control methods. Table II summarizes the results comparison of different power control algorithms. Using the QPC method, ranging error below 10cm/5cm occurs in more than 91%/60% of the measurements, respectively. The worst case is 18cm. SPC method gets the ranging error that below 10cm/5cm occurs in more than 85%/50% of the measurements, respectively. The worst case is 60cm. FPC method obtains the most accurate ranging estimates, its ranging error below 10cm/5cm occurs in more than 94%/80% of the measurements, respectively. The worst case is 20cm. Without power control, using the NPC method, ranging error below 10cm/5cm occurs in less than 20%/5% of the measurements, respectively. The worst case is greater than 1m.

To measure the transmit-power efficiency for the respective algorithms, the transmit-power efficiency for any one con-

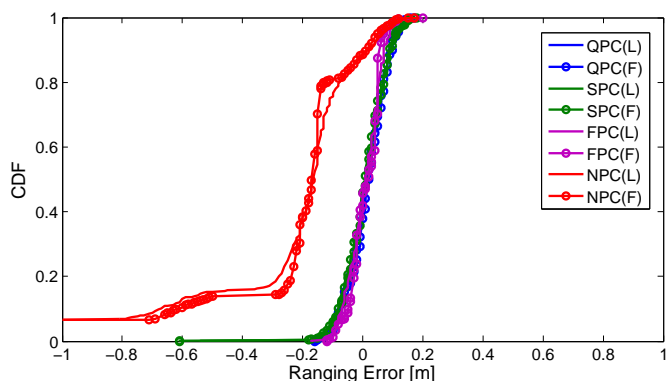

Fig. 9: CDF of the ranging error for stationary test using power control methods from 2.5m to 30m.

TABLE II: Stationary Ranging Results Comparison of QPC, SPC,FPC, NPC

	QPC	SPC	FPC	NPC
Power Update Rate (cycle)	1	10	1	0
Power Update Value (dBm)	$1.5e_j(t)$	$1.5e_j(t)$	± 1.5	Null
Measurements	4800	4800	4800	4800
Accuracy > 10cm	>91%	>85%	>94%	<20%
Accuracy > 5cm	>60%	>50%	>80%	<12%
Worst Case	18cm	60cm	20cm	0-> 1m

troller configuration is defined as the average transmit-power consumed by two transceivers operating using a particular power control algorithm for the duration of an experiment. For example 100% transmit-power efficiency in this context would imply that the mote is transmitting using its minimum output power setting. Fig.10 plots the percentage transmit-power efficiency for each of the mote control configuration. The utilization of power control methods can get more transmit-power efficiency (up to 99%) than non-power control method (47%). With the distance increasing from 2.5m to 30m, the transmit-power efficiency of the power control methods decreases from 99% to 50%, that because of the controller increases the output power to maintain SNR and connectivity.

B. Mobile power control test

The mobile ranging test is made to observe the performance of the power control method in the real-world environment with uncertain factors such as the motion of the leader and time-varying wireless channel. Being subjective, the SPC method with lower power updating rate is not powerful for the mobile ranging when compared to the QPC and FPC methods. Thus, in this section, we only consider the NPC, FPC and QPC. The follower (F) is stationary for the duration of the experiment. The leader (L) moves from 1m (from the follower) in a straight line to a distance of 8m with an approximate constant velocity of (20.4 sec/m), see Fig.2 (d).

The QPC (blue line) and FPC (violet line) methods adjust transmit-power according to whether the SNR is greater or less than the target SNR (43dB), see Fig.11 (a). The NPC method keeps the maximum transmit-power (red line). Before the 100th frame point, both UWB transceivers employing QPC

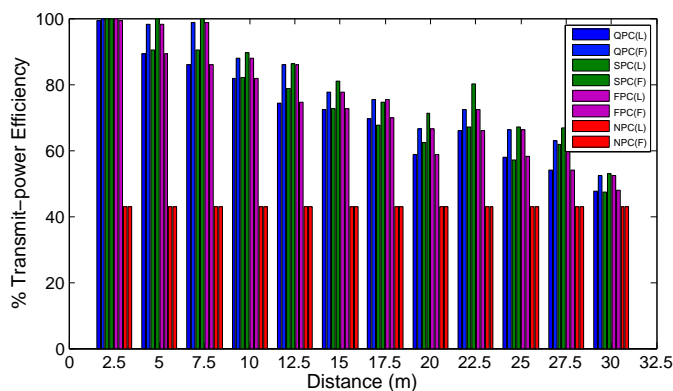

Fig. 10: Transmit-power efficiency from 2.5m to 30m.

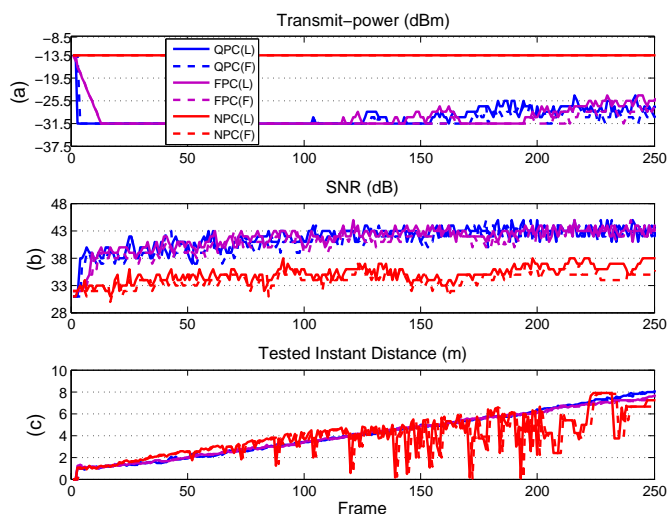

Fig. 11: Transmit-power control in mobile condition.

and FPC use minimum transmit-power (-31.5dBm) and the SNRs are less than 43dB. However, the value of the SNRs increases with distance increasing, see Fig.11 (b). Whereas, the SNRs obtained from the NPC are always less than 38dB, but the value increases with distance increasing from the starting point (32dB). In Fig.11 (c), the leader moves from 1m (starting at about 13 frames point) to the end (8m test-point) with a approximate velocity (34frames/m). When employing power control methods (QPC and FPC), the slopes of the ranging curve of both transceivers approximately meet the velocity. The power controlled ranging channel is more stable than non-power control (NPC) which obtains highly variable ranging estimates (0 ~ 4m difference) during the moving period.

VI. CONCLUSION

In this paper, we presented the bilateral transmitter output power control algorithm to deal with the effects of multipath propagation. This technique does not require changing the ranging protocol and time-of-arrival estimation method. To validate this technique in realistic scenarios, we performed an extensive indoor measurement campaign using FCC-compliant IEEE 802.15.4a impulse UWB radios. The bilateral power

control method that is capable of dynamically controlling the outputs of the 802.15.4a transceivers to optimize the SNR of leading path signal. We observe that our bilateral power control method can: (1) cooperate seamlessly with a practical symmetric double-sided two-way ranging method; (2) compensate for uncertain multi-path effects and maintain connectivity and (3) significantly improve the ranging performance for multipath environments for both the stationary and mobile case in line-of-sight conditions.

ACKNOWLEDGMENT

This work was supported by Networked Embedded Systems (NEMES) project, High Education Authority (HEA) Programme for Research in Third Level Institutions (PRTL)-Cycle 4.

REFERENCES

- [1] M. Z. Win and R. A. Scholtz. "Characterization of ultra-wide bandwidth wireless indoor communications channel: A communication theoretic view". *IEEE J. Sel. Areas Commun.*, vol. 20, no. 9, pp. 1613-1627, Dec. 2002.
- [2] J.-Y. Lee and R. A. Scholtz. "Ranging in a dense multipath environment using an UWB radio link". *IEEE J. Sel. Areas Commun.*, vol. 20, no. 9, pp. 1677-1683, Dec. 2002.
- [3] D. B. Jourdan, D. Dardari and M. Z. Win. "Position error bound for UWB localization in dense cluttered environments". *IEEE Trans. Aerosp. Electron. Syst.*, vol. 44, no. 2, pp. 613-628, Apr. 2008.
- [4] IEEE working group 802.15.4a. Wireless Medium Access Control (MAC) and Physical Layer (PHY) Specifications for Low-Rate Wireless Personal Area Networks (WPANs). Alternate PHYs. NJ: IEEE, 2007.
- [5] P. Cheong, A. Rabbachin, J. Montillet, K. Yu and I. Oppermann. "Synchronization, TOA and position estimation for low-complexity LDR UWB devices". *IEEE Int. Conf. Ultra-Wideband (ICUWB)*, Zurich, Switzerland, pp.480-484, Sep. 2005.
- [6] A. A. DAmico, U. Mengali, and L. Taponecco. "Energy-based TOA estimation". *IEEE Trans. Wireless Commun.*, vol. 7, pp. 838-847, Mar. 2008.
- [7] T. Ye, M. Walsh and B. OFlynn. "Experimental Analysis of Transmit-power for IEEE 802.15.4a UWB Ranging under Multipath Environment". *ISSC*, NUI Maynooth, June 28-29, 2012.
- [8] X. Li and K. Pahlavan. "Super-resolution TOA estimation with diversity for indoor geolocation". *IEEE Trans. Inf. Theory*, vol. 3, no. 1, pp. 224-234, 2004.
- [9] Y. Luo and C. L. Law. "A least-squares algorithm for multipath estimation using an UWB-IR link". in *Proc. IEEE Wireless Commun., Netw. Conf.*, pp. 1-6, 2010.
- [10] D. Chazan, M. Zakai, and J. Ziv. "Improved lower bounds on signal parameter estimation". *IEEE Trans. Inf. Theory*, vol. IT-21, pp. 90-93, Jan. 1975.
- [11] R. D. Yates. "A framework for uplink power control in cellular radiosystems". *IEEE Journal on Selected Areas in Communications*, vol.13, pp.1341-1347,Sept.1995.
- [12] M. J. Walsh and M. J. Hayes. "Robust Power Aware Mobile Agent Tracking using an 802.15.4 Wireless Sensor Network". *IET Mechatronics*, 2008.
- [13] M. Gabriella, D. Benedetto and G. Giancola, "Understanding Ultra Wide Band Radio Fundamentals". *Prentice Hall*, 2004.
- [14] www.decawave.com